

HIGHBURY POOLS LTD

LAZY-L RIGHT LINER ORDER FORM
HIGHBURY POOLS LTD
Tel: 519-659-7000 | Fax: 519-659-7867

SERIAL #

DEALER NAME:

PERIMETER:

DATE:

TAG:

WALL PATTERN:

TELEPHONE #:

BEAD TYPE/COLOUR:

GAUGE:

FAX #:

SHIP WITH (PREFERRED CARRIER):

MEASURED BY:

REQUIRED DATE:

Select Corner Type:

Square

Radius

Diagonal

Select Slope Type:

Standard

Convex

Concave

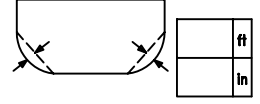
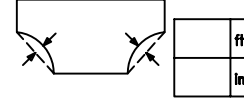
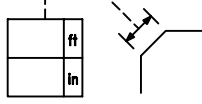
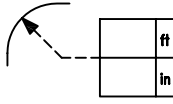
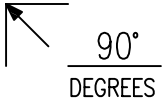

LOOKING TOWARDS DEEP END

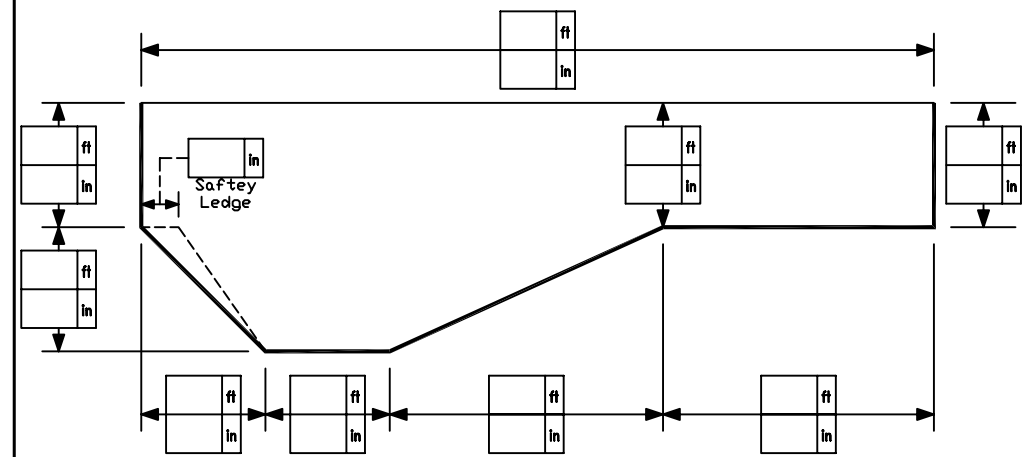
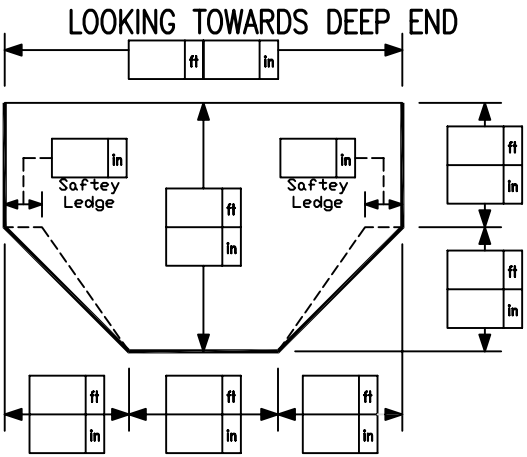

Please mark desired location of wall seam/steps with a (*) on Plan View.

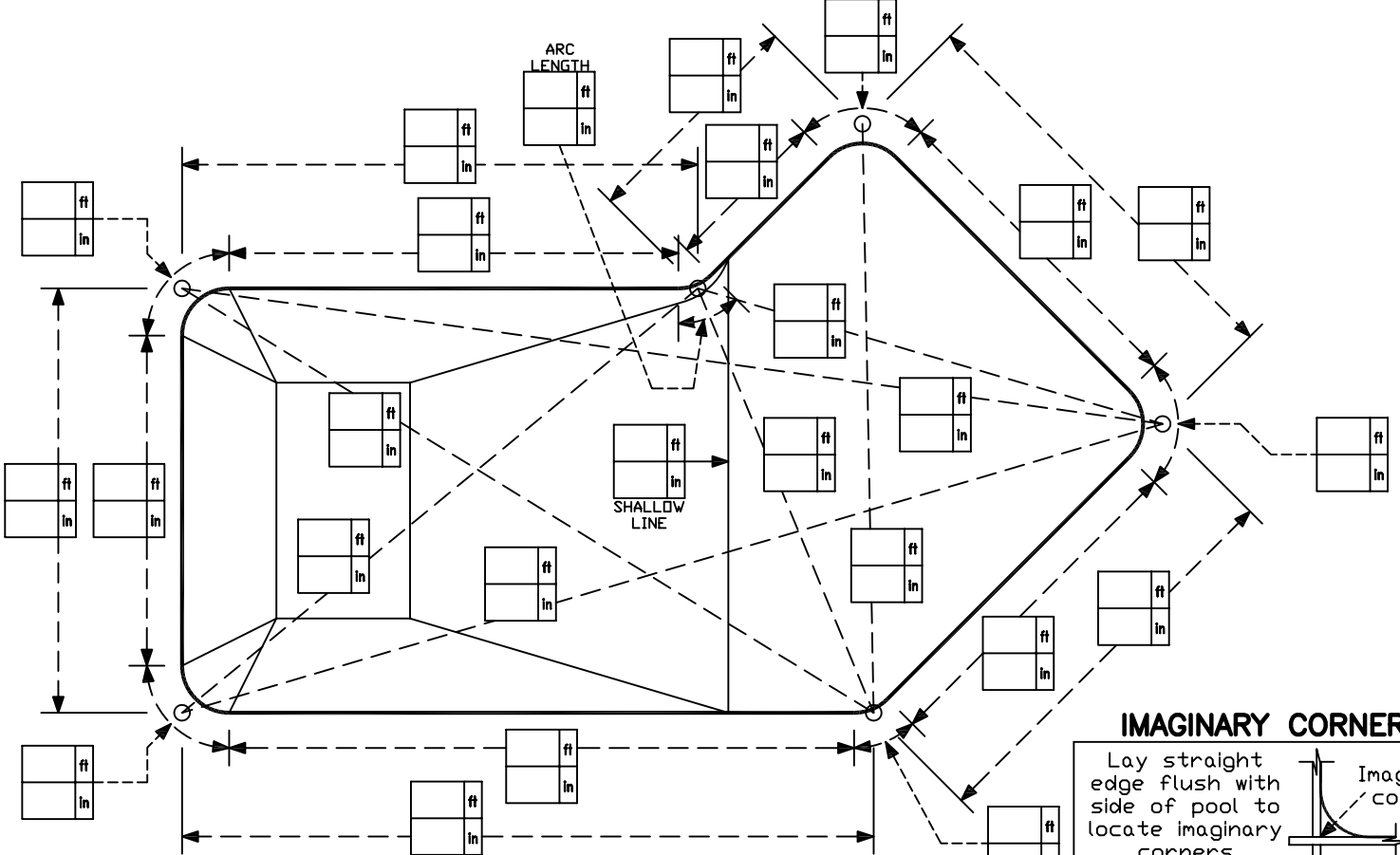

IMAGINARY CORNERS

Lay straight edge flush with side of pool to locate imaginary corners

